



Univerzitet u Beogradu, Građevinski fakultet



Merenje protoka u otvorenim tokovima – Projektovanje mernog suženja



Merenja u hidrotehnici

6. Vežba

Miloš Milašinović

Damjan Ivetić

Dušan Prodanović

Nemanja Branisljević



MERENJE OSNOVNIH VELIČINA U HIDROTEHNICI

- Merenje pritiska: pjezorezistivni, kapacitivni, induktivni senzori
- Merenje nivoa vode: ultrazvučni senzori, senzori pritiska + preračunavanje
- Merenje brzine: UZV, EM, hot-wire i hot-film, ...
- Merenje protoka: volumetrijsko, UZV, EM, **suženja...**

+ merenje kvaliteta vode: pH, mutnoća, elektroprovodnost

MERENJE PROTOKA – MERNI SUŽENJE

Merno suženje – merenje protoka u otvorenim tokovima na osnovu merenja jedne ili dve dubine

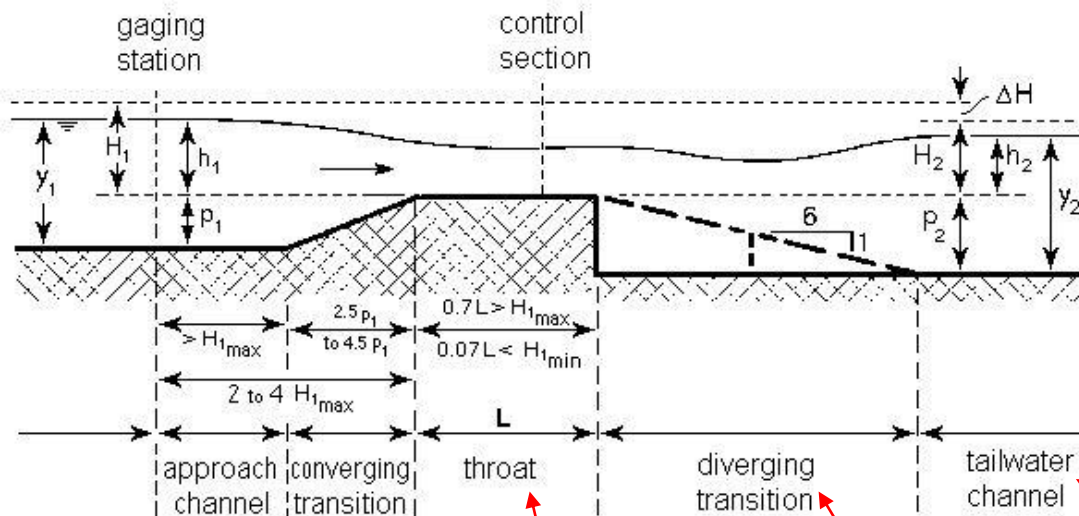

Koju dubinu meriti i kako?

Prilazna – uzvodna deonica

Prelazna deonica

„Grlo“ - suženje

Proširenje – vraćanje na geometriju kanala

Nizvodna deonica

MERENJE PROTOKA – MERNO SUŽENJE

Merno suženje – kako meriti protok preko dubine?

- Potrebno je ustanoviti koja dubina se meri i koja je funkcionalna zavisnost protoka od dubine
- Funkcionalna zavisnost $Q=f(h)$ poznata za kritičnu dubinu (preko Frudovog broja)
- Merno suženje omogućava formiranje kritične dubine h_{kr}
- **Da li se u suženju zna gde je tačno kritična dubina?!**

Ne znamo gde je tačno kritična dubina, ne možemo da je izmerimo, ali znamo da se javlja negde u suženju!!!

MERENJE PROTOKA – MERNO SUŽENJE

Merno suženje – kako meriti protok preko dubine?

- Ne meri se dubina u suženju, već se meri dubina negde uzvodno
- Miran režim uzvodno - manja neodređenost pri merenju dubine
- Funkcionalna zavisnost $Q=f(h_{uzv})$ – na osnovu Bernulijeve jednačine od preseka uzvodno do preseka u suženju
- Samo se uzima lokalni gubitak energije

MERENJE PROTOKA – MERNO SUŽENJE

Merno suženje – kako meriti protok preko dubine?

Cilj – meriti dubinu uzvodno h_1 , i na osnovu $Q=f(h_1)$ dobiti protok

$$h_1 + \frac{Q^2}{2gA_1^2} = h_2 + \frac{Q^2}{2gA_2^2} (1 + \xi)$$

$$Fr_{r,2} = \frac{Q^2 B_2}{gA_2^3} = 1$$



Kombinacijom ove dve jednačine i rešavanjem po h_1 dobija se funkcionalna zavisnost (jednoznačna veza) između protoka Q i dubine **uzvodno** od suženja h_1



$$Q = f(h_1)$$

Kriva protoka

h_1, h_2 – uzvodna dubina i dubina na suženju

Q – protok

A_1, A_2 – površine poprečnih preseka

ξ - koeficijent lokalnog gubitka na suženju

MERENJE PROTOKA – MERNO SUŽENJE

Kako isprojektovati merno suženje?

- Odrediti dužinu prilazne deonice, dužinu uzvodne prelazne deonice, dužinu suženja (i visinu praga u suženju), dužinu i nagib nizvodne prelazne deonice i eventualno dubinu ukopavanja nizvodne deonice
- Uslovi za projektovanje – da se u opsegu između minimalnog i maksimalnog predviđenog Q , i pri odgovarajućim nizvodnim graničnim uslovima javi nepotopljeno tečenje u suženju

MERENJE PROTOKA – MERN SUŽENJE

Kako isprojektovati merno suženje?

- Da bi projekat bio kompletan, potrebno je predvideti način merenja nivoa u preseku uzvodno i neodređenost takvog merenja
- Formirati i krivu protoka za suženje

MERENJE PROTOKA – MERNO SUŽENJE

Kako isprojektovati merno suženje?

- Projektovanje se radi u besplatnom softveru pod nazivom WinFlume - USBR



Link za download

<https://www.usbr.gov/tsc/techreferences/computer%20software/software/winflume/32bitwinflumedownload.html>

MERENJE PROTOKA – MERNOSUŽENJE

WinFlume – Pokretanje programa i podešavanja

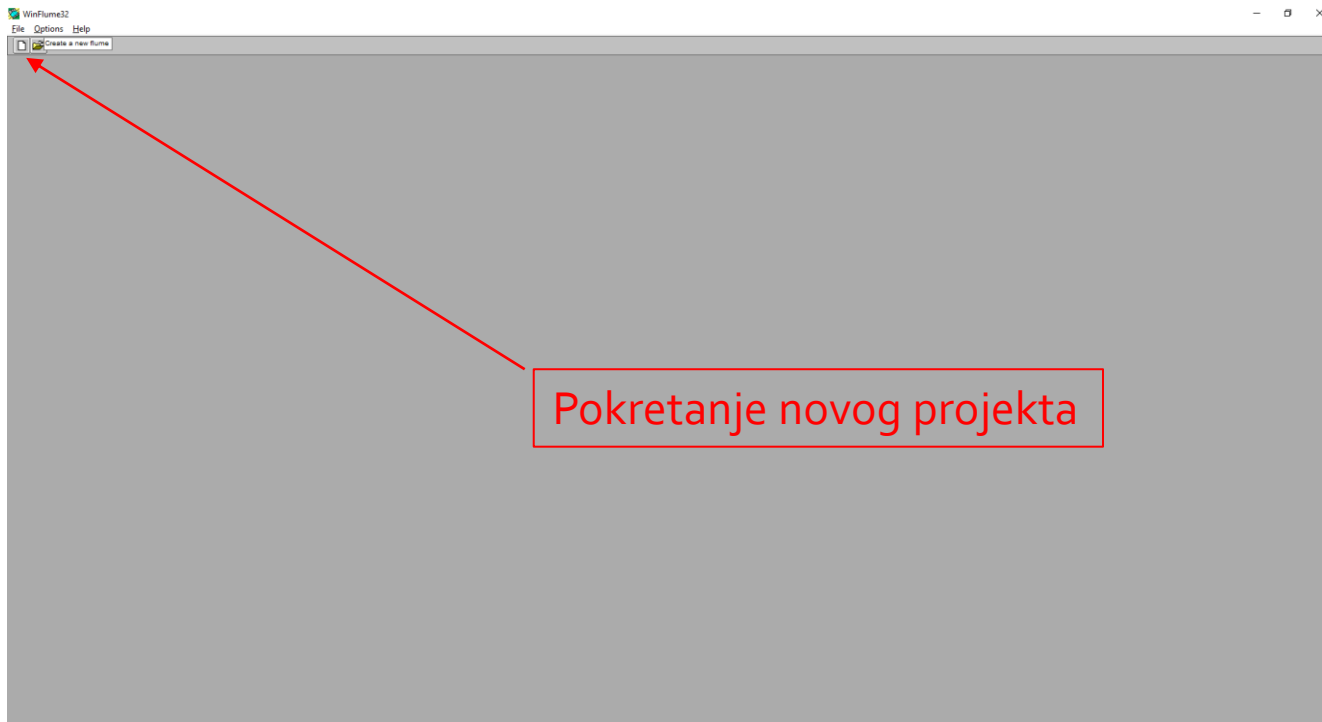

MERENJE PROTOKA – MERNOSUŽENJE

WinFlume – Pokretanje programa i podešavanja

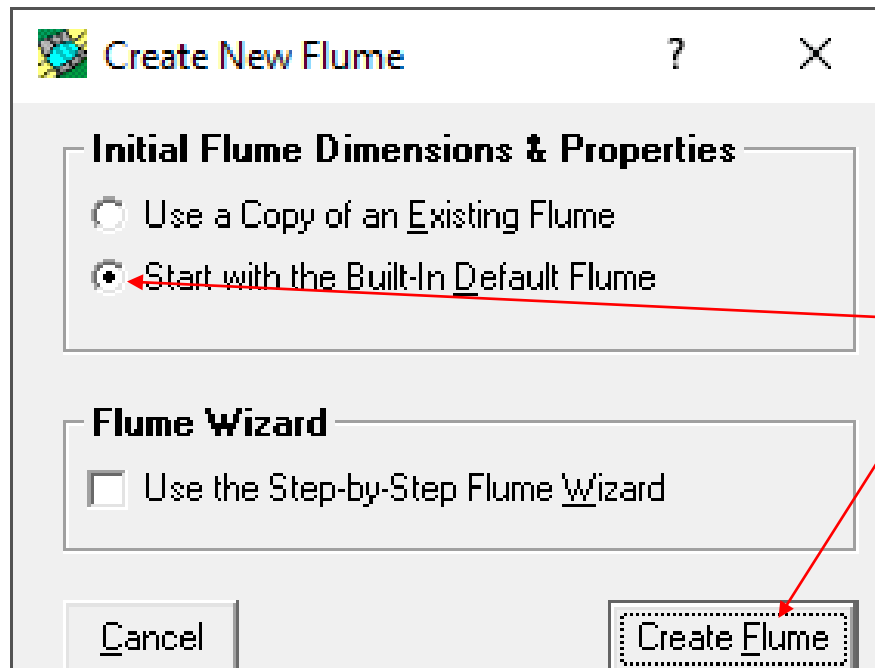

Pokretanje novog projekta od početka

MERENJE PROTOKA – MERNO SUŽENJE

WinFlume – Pokretanje programa i podešavanja

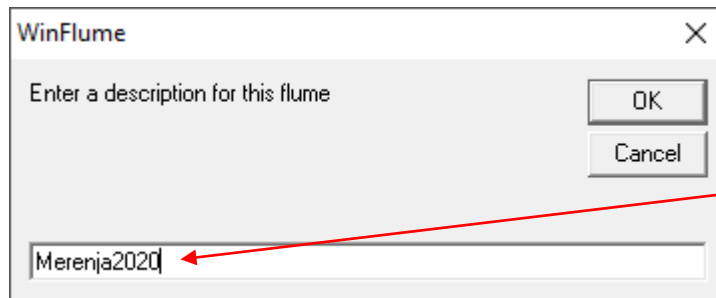

Imenovanje projekta (po izboru)

MERENJE PROTOKA – MERNOSUŽENJE

WinFlume – Pokretanje programa i podešavanja

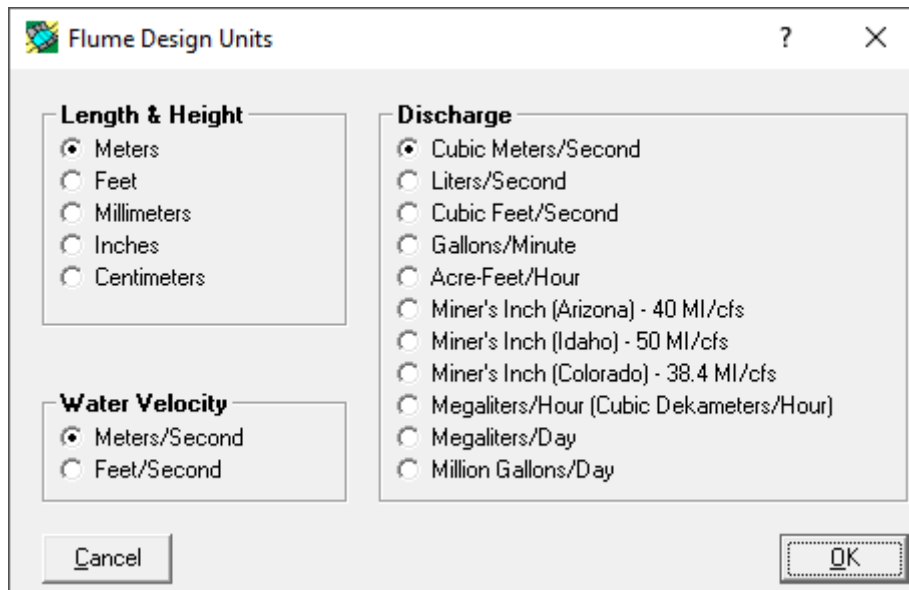

Podešavanje metričkog sistema

MERENJE PROTOKA – MERNO SUŽENJE

WinFlume – Radno okruženje - situacija

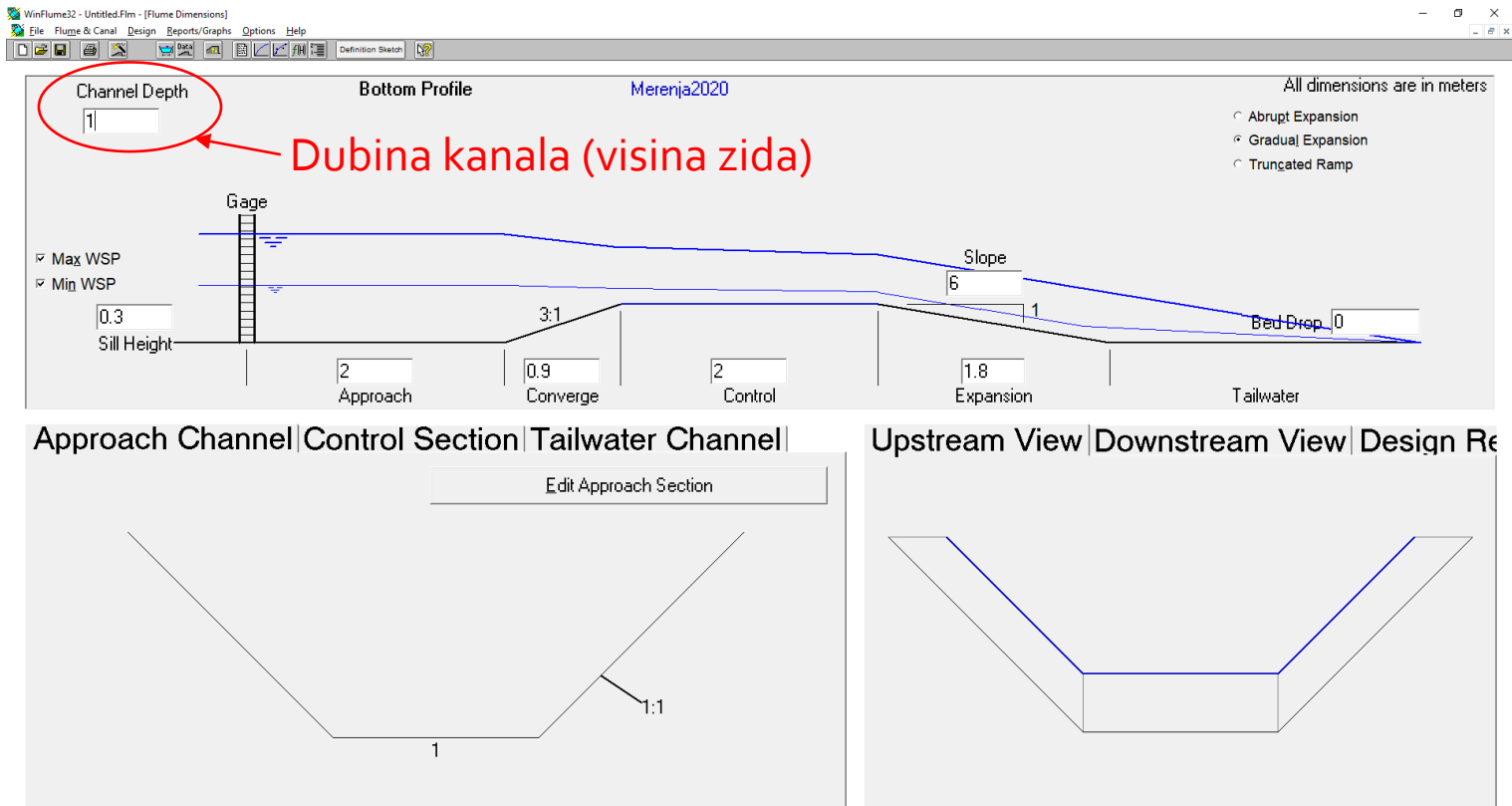

MERENJE PROTOKA – MERNOSUŽENJE

WinFlume – Radno okruženje - situacija

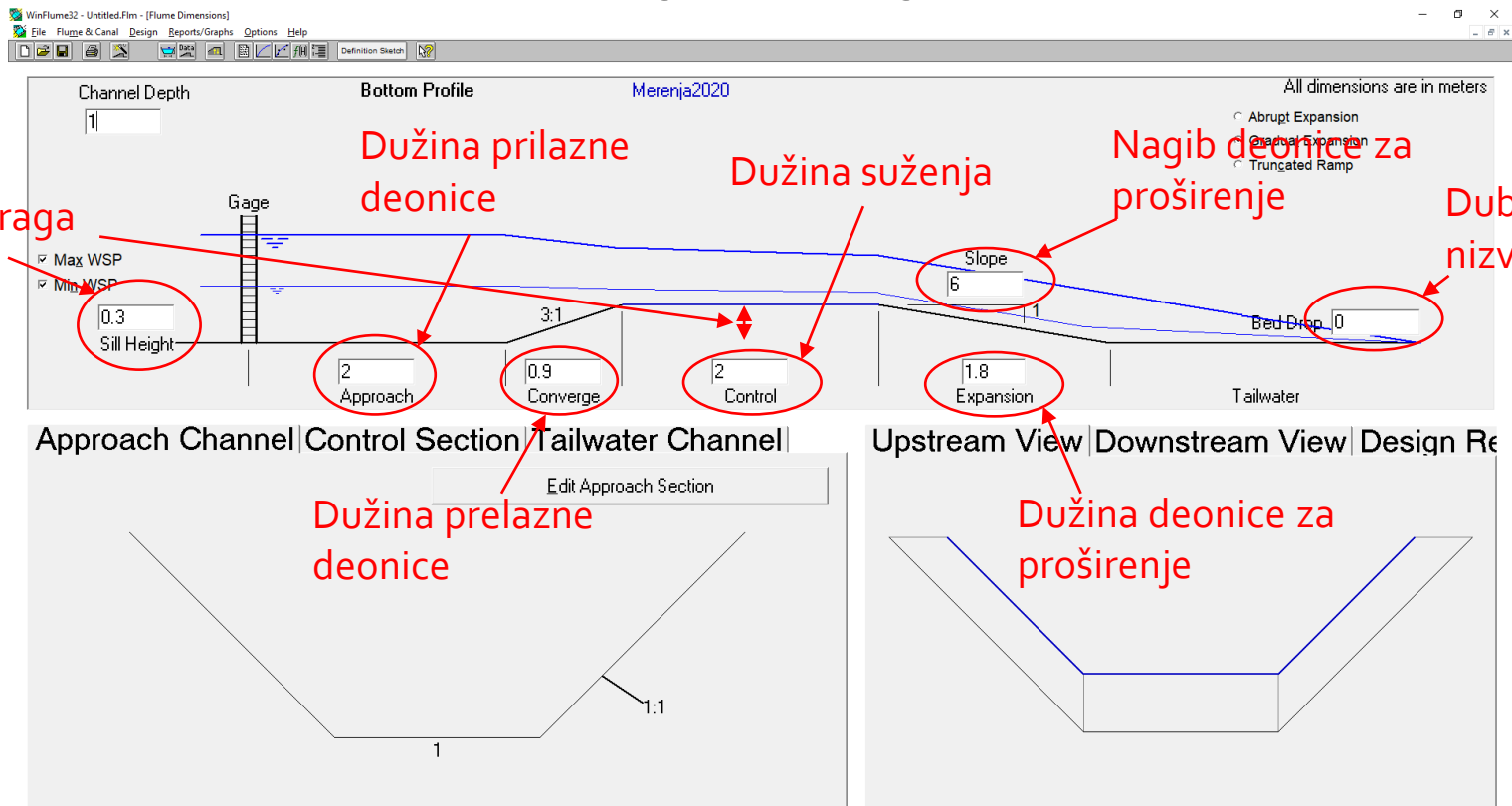

MERENJE PROTOKA – MERNO SUŽENJE

WinFlume – Radno okruženje - situacija

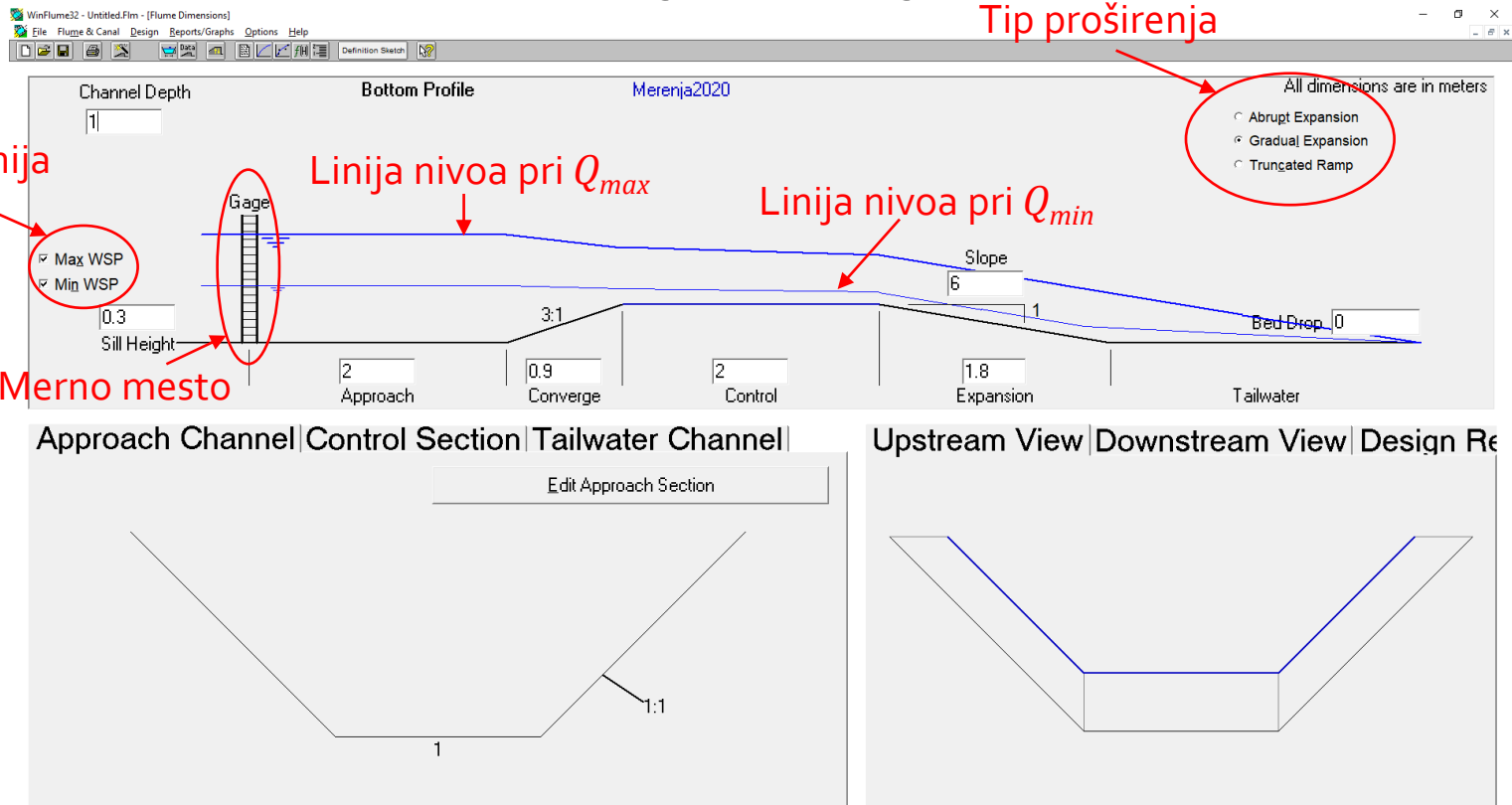

MERENJE PROTOKA – MERNOSUŽENJE

WinFlume – Radno okruženje – poprečni preseki

The screenshot displays the WinFlume software interface for channel design. The main window shows a 'Bottom Profile' graph with various sections: Approach (2m), Converge (0.9m), Control (2m), Expansion (1.8m), and Tailwater. A 'Gage' is positioned at the start of the Approach section. The 'Channel Depth' is set to 1m. The 'Sill Height' is 0.3m. The 'Slope' is 6, and the 'Bed Drop' is 0. The 'Bottom Profile' graph shows the channel bed and water surface profiles. The 'Approach Channel' section is highlighted with a red circle. Below the main window, there are two cross-section views: 'Upstream View' and 'Downstream View'. The 'Upstream View' shows a trapezoidal channel cross-section with a bottom width of 1m and a slope of 1:1. The 'Downstream View' shows a rectangular channel cross-section. The 'Design Re' view is also visible. The software interface includes a menu bar (File, Flume & Canal, Design, Reports/Graphs, Options, Help) and a toolbar. The title bar indicates 'WinFlume32 - Untitled Flm - [Flume Dimensions]'. The status bar at the bottom indicates 'Definition Sketch'.

Channel Depth: 1

Bottom Profile: Merenja2020

All dimensions are in meters

Channel sections: Approach (2), Converge (0.9), Control (2), Expansion (1.8), Tailwater

Parameters: Sill Height (0.3), Slope (6), Bed Drop (0)

Options: Max WSP, Min WSP

Expansion types: Abrupt Expansion, Gradual Expansion, Truncated Ramp

Approach Channel | Control Section | Tailwater Channel

Upstream View | Downstream View | Design Re

Poprečni presek prilazne deonice

Editovanje (korekcija) poprečnog preseka

MERENJE PROTOKA – MERNOSUŽENJE

WinFlume – Radno okruženje – poprečni preseki

The screenshot displays the WinFlume software interface for defining a channel. The main window shows a 'Bottom Profile' graph with various sections: Approach (2m), Converge (0.9m), Control (2m), Expansion (1.8m), and Tailwater. A 'Gage' is positioned at the start of the channel. The 'Channel Depth' is set to 1m. The 'Sill Height' is 0.3m. The 'Slope' is 6, and the 'Bed Drop' is 0. The 'Max WSP' and 'Min WSP' checkboxes are checked. The 'Definition Sketch' toolbar is visible at the top.

Below the main profile, there are two panels for cross-sections:

- Approach Channel Control Section Tailwater Channel:** This panel shows a trapezoidal cross-section. A red circle highlights the 'Control Section' label. A red arrow points to the text 'Poprečni presek u suženju' (Cross-section in constriction). Another red arrow points to the 'Edit Approach Section' button, with the text 'Editovanje (korekcija) poprečnog preseka' (Editing (correction) of the cross-section).
- Upstream View | Downstream View | Design Re:** This panel shows a 3D perspective view of the channel cross-section.

All dimensions are in meters.

MERENJE PROTOKA – MERNO SUŽENJE

WinFlume – Radno okruženje – poprečni preseči

The screenshot displays the WinFlume software interface for a flume design project. The main window shows a 'Bottom Profile' graph with various sections: Approach (2m), Converge (0.9m), Control (2m), Expansion (1.8m), and Tailwater. A 'Gage' is positioned at the start of the Approach section. The graph includes water surface elevation lines and a channel bed profile. Parameters like 'Slope' (6) and 'Bed Drop' (0) are visible. A red circle highlights the 'Tailwater Channel' section in the 'Approach Channel | Control Section | Tailwater Channel' tabs. Below the graph, two cross-section views are shown: 'Upstream View' and 'Downstream View'. Red arrows point from the 'Tailwater Channel' tab to the 'Upstream View' cross-section, labeled 'Poprečni presek nizvodne deonice', and to the 'Downstream View' cross-section, labeled 'Editovanje (korekcija) poprečnog preseka'. The 'Upstream View' shows a trapezoidal channel with a 1:1 slope and a bottom width of 1. The 'Downstream View' shows a similar trapezoidal channel with a wider bottom.

Channel Depth: 1

Bottom Profile: Merenja2020

All dimensions are in meters

Channel sections: Approach (2), Converge (0.9), Control (2), Expansion (1.8), Tailwater

Parameters: Sil Height (0.3), Max WSP, Min WSP, Slope (6), Bed Drop (0)

Options: Abrupt Expansion, Gradual Expansion, Truncated Ramp

Approach Channel | Control Section | **Tailwater Channel**

Upstream View | Downstream View | Design Re

Poprečni presek nizvodne deonice

Editovanje (korekcija) poprečnog preseka

MERENJE PROTOKA – MERNI SUŽENJE

WinFlume – Radno okruženje – poprečni preseki

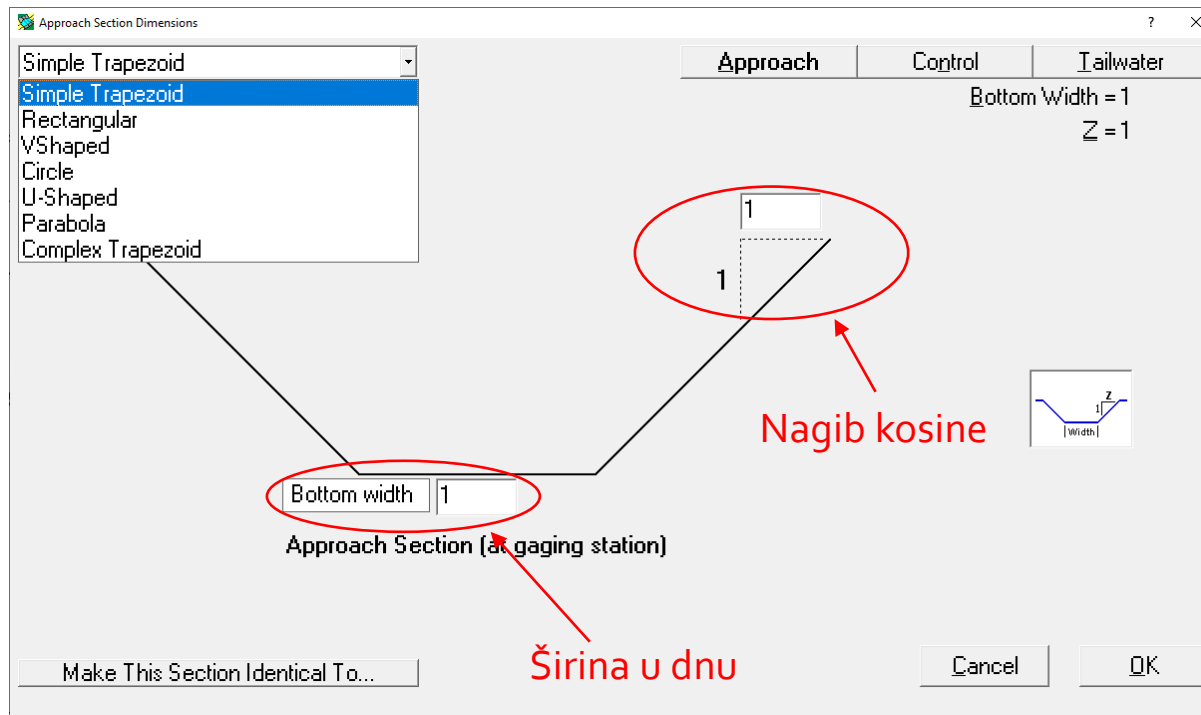

Editovanje (korekcija)
poprečnog preseka

Nagib kosine

Širina u dnu

MERENJE PROTOKA – MERNOSUŽENJE

WinFlume – Radno okruženje - pogled

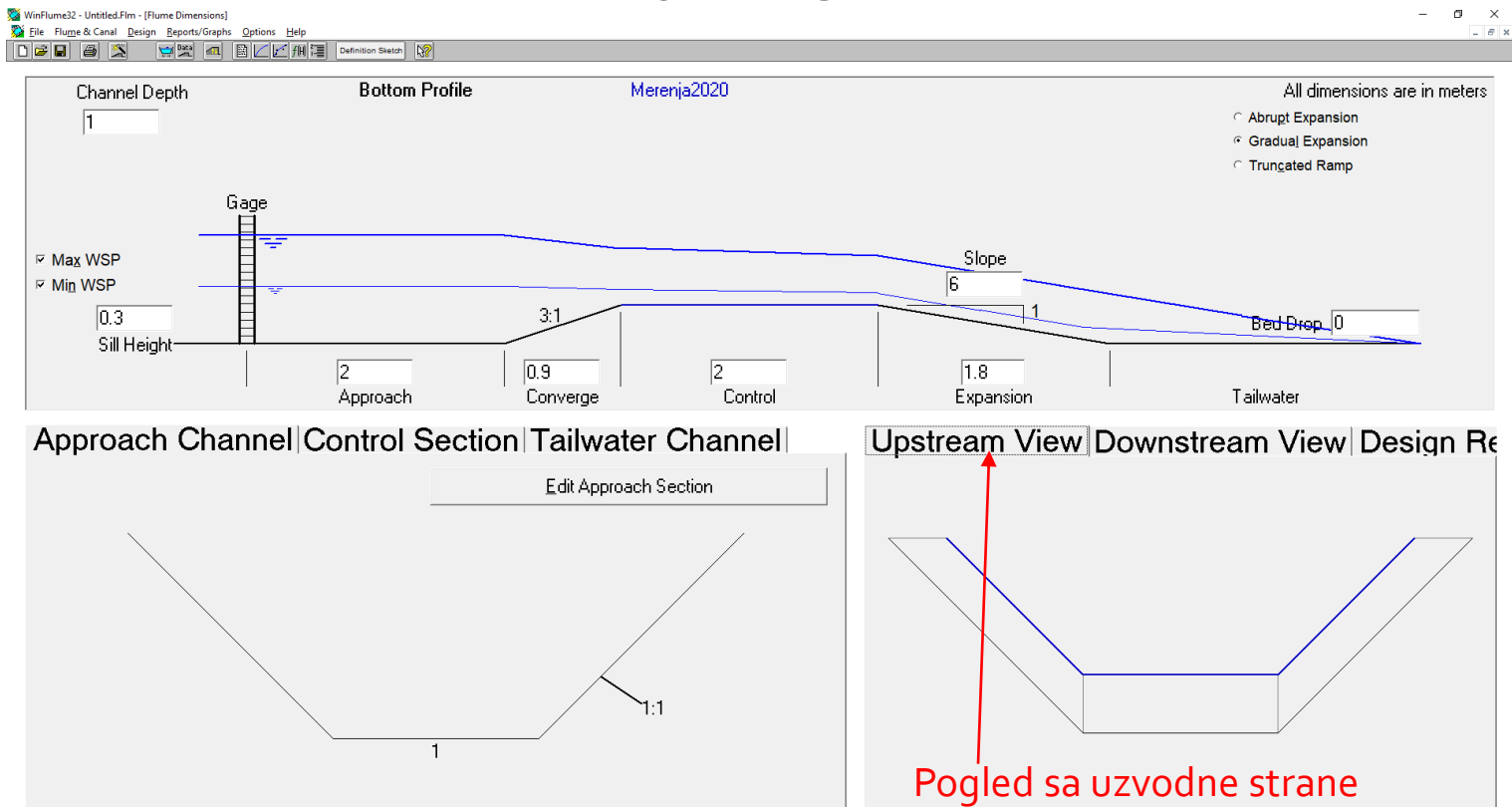

MERENJE PROTOKA – MERNOSUŽENJE

WinFlume – Radno okruženje - pogled

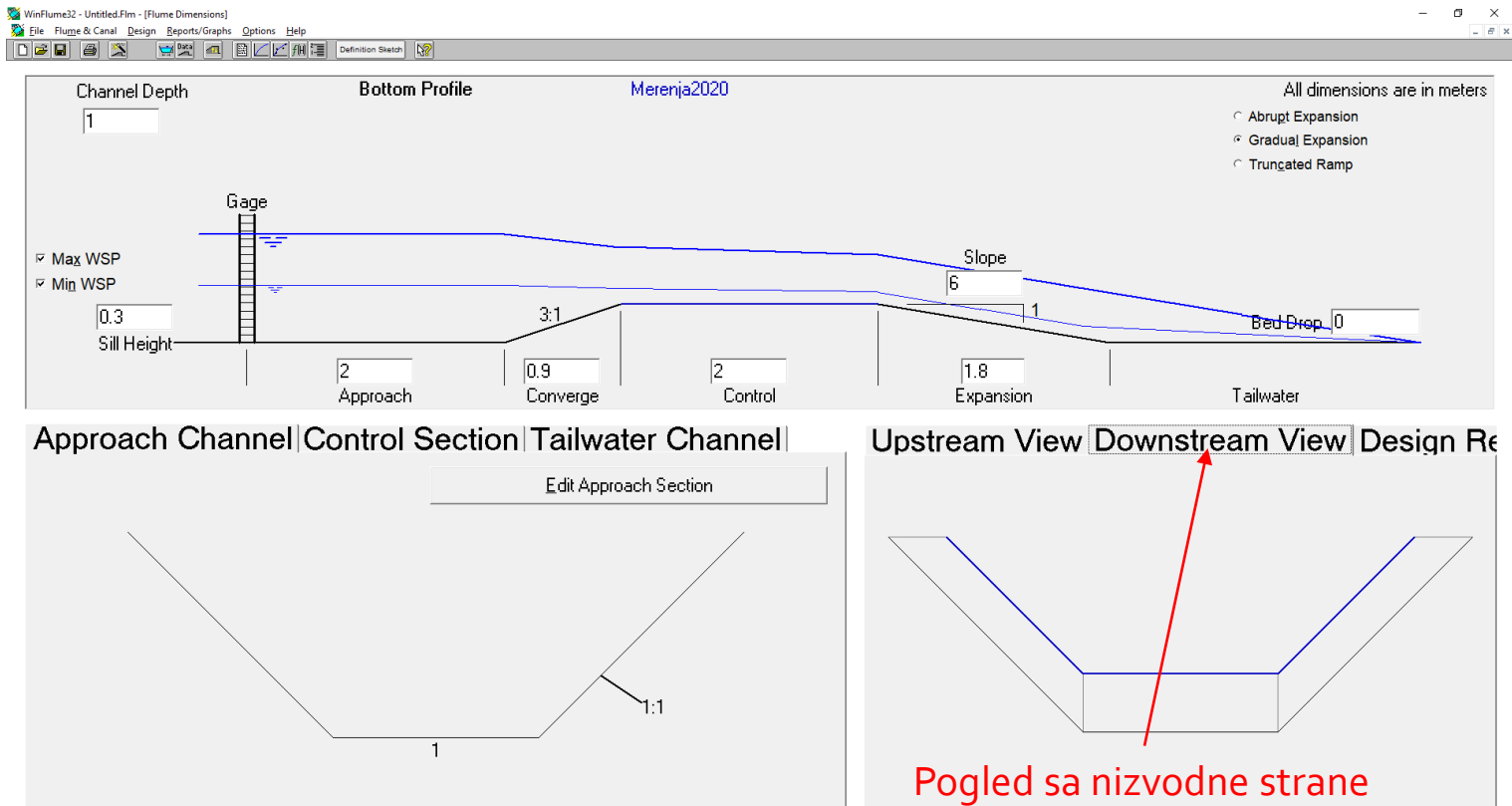

MERENJE PROTOKA – MERNOSUŽENJE

WinFlume – Radno okruženje – projektni kriterijumi

The screenshot displays the WinFlume software interface for channel design. The main window shows a cross-section of a channel with various sections: Approach (2m), Converge (0.9m), Control (2m), Expansion (1.8m), and Tailwater. A gage is positioned in the Approach section. The channel depth is set to 1 meter. The bottom profile is labeled 'Merenja2020'. The design is evaluated against several criteria, all of which are marked as 'Ok'.

Channel Depth: 1

Bottom Profile: Merenja2020

All dimensions are in meters

- Abrupt Expansion
- Gradual Expansion
- Truncated Ramp

Max WSP: Min WSP:

Sill Height: 0.3

Approach: 2

Converge: 0.9

Control: 2

Expansion: 1.8

Tailwater

Bed Drop: 0

Slope: 6

1

Approach Channel | Control Section | Tailwater Channel

Edit Approach Section

Upstream View | Downstream View | Design Re

Design is acceptable.

$Q_{max} = 1.0000$ cu. m/s

$Q_{min} = 0.1000$ cu. m/s

EVALUATION OF DESIGN CRITERIA

- Ok. Froude number @ $Q_{max} = 0.285$
- Ok. Freeboard @ $Q_{max} = 0.153$ m
- Ok. Submergence Protection @ $Q_{max} = 0.800$ m
- Ok. Submergence Protection @ $Q_{min} = 0.432$ m
- Ok. Expected uncertainty @ $Q_{max} = \pm 2.51$ %
- Ok. Expected uncertainty @ $Q_{min} = \pm 2.70$ %

Svuda stoji Ok. ako su ispunjeni!!!

Ispunjenost projektnih kriterijuma

MERENJE PROTOKA – MERNOSUŽENJE

WinFlume – Radno okruženje – projektni kriterijumi

The screenshot displays the WinFlume software interface for channel design. The main window shows a cross-section of a channel with various sections: Approach (2m), Converge (0.9m, 3:1 slope), Control (2m), Expansion (1.8m, 1:6 slope), and Tailwater. A gage is positioned in the approach section. The channel depth is set to 1 meter. The bottom profile is labeled 'Merenja2020'. The interface includes a toolbar, a menu bar (File, Flume & Canal, Design, Reports/Graphs, Options, Help), and a status bar (Definition Sketch).

Channel Depth: 1

Bottom Profile: Merenja2020

All dimensions are in meters

- Abrupt Expansion
- Gradual Expansion
- Truncated Ramp

Max WSP

Min WSP

Sill Height: 0.3

Approach: 2

Converge: 0.9

Control: 2

Expansion: 1.8

Tailwater

Bed Drop: 0

Approach Channel | Control Section | Tailwater Channel

Edit Approach Section

Upstream View | Downstream View | Design Re: **Design Re: [Not Ok]**

Design is NOT acceptable, but may be improved.
Type CTRL+D for detailed design review

Qmax = 1.0000 cu. m/s
Qmin = 0.1000 cu. m/s

EVALUATION OF DESIGN CRITERIA

- Ok: Froude number @ Qmax = 0.208
- Ok: Freeboard @ Qmax = 0.153 m
- Ok: Submergence Protection @ Qmax = 0.107 m
- Ok: Submergence Protection @ Qmin = 0.231 m
- Ok: Expected uncertainty @ Qmax = ±1.93 %
- Not Ok: Expected uncertainty @ Qmin = ±2.19 %

Stoji Not Ok. kod onog koji nije ispunjen!!!

Ispunjenost projektnih kriterijuma

MERENJE PROTOKA – MERNOSUŽENJE

WinFlume – Unos podataka za projektovanje

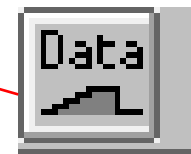
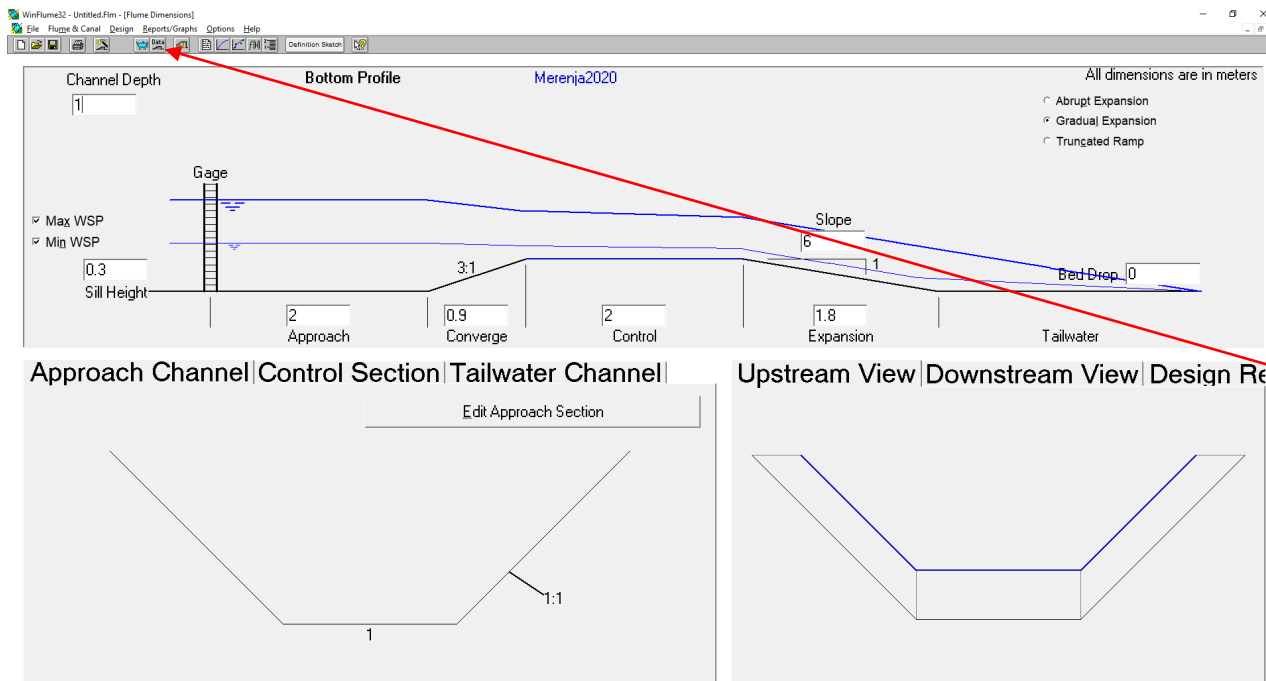

MERENJE PROTOKA – MERNOSUŽENJE

WinFlume – Unos podataka za projektovanje – tip podloge

Flume Properties, Canal Data, & Design Requirements

Flume Description: Merenja2020 Revision 1

Flume Crest | Discharge & Tailwater | Head Measurement | Freeboard Requirement

Stationary Crest ← **Nepokretno dno**

Movable Crest

Flume Construction Material: Concrete - smooth

Roughness Height: 0.00015 meters

Tip podloge – Izabrati gladak beton

Procenjena apsolutna hrapavost podloge

Cancel OK

MERENJE PROTOKA – MERNO SUŽENJE

WinFlume – Unos podataka za projektovanje – tip podloge

The screenshot shows the 'Flume Properties, Canal Data, & Design Requirements' dialog box. The 'Flume Description' is 'Merenja2020'. The 'Flume Crest' tab is selected, showing 'Discharge & Tailwater' and 'Head Measurement' sub-tabs. The 'Range of Flume Operation' section contains a table with the following data:

	Discharge	Unit	Tailwater Level, y2	Unit
Minimum Flow to be Measured	0.1	cu. m/s	0.190	meters
Maximum Flow to be Measured	1	cu. m/s	0.693	meters

The 'Tailwater Calculations' section shows the 'Method' as 'Manning's equation using n and S'. The 'Manning's n' field is set to 0.02. The 'Bed Slope (Hydraulic Gradient)' field is set to 0.001 m/m. A list of Manning's n-values is visible, including 'LINED OR BUILT-UP CHANNELS', 'EXCAVATED OR DREDGED CHANNELS', 'MINOR NATURAL STREAMS, TOP WIDTH AT Qmax < 30 met', 'CLOSED CONDUITS FLOWING PARTLY FULL, METALLIC', and 'CLOSED CONDUITS FLOWING PARTLY FULL, NON-METALL'. The 'Cancel' and 'OK' buttons are at the bottom.

Min i Max protok

Dubine nizvodno za Q_{min} i Q_{max}

Dobijaju se na osnovu Šezi-Manigove jednačine

Manningova hrapavost
(uneti kako je u
zadatku)

Nagib kanala - % ili ‰
pretvoriti u decimalni
oblik

MERENJE PROTOKA – MERNO SUŽENJE

WinFlume – Izbor načina merenja nivoa

Flume Properties, Canal Data, & Design Requirements

Flume Description: Merenja2020 Revision 1

Flume Crest | Discharge & Tailwater | **Head Measurement** | Freeboard Requirement

Head Measurement Method: Point gage in stilling well Expected Uncertainty: ± 0.0001 meters

Allowable flow measurement uncertainty (95% uncertainty of a single measurement)

At Minimum Flow	±	2.5	%
At Maximum Flow	±	2.5	%

Totalizing or Averaging

Measurement Interval: 1 seconds

Duration: 1 seconds

Cancel OK

Merni instrument za merenje dubine h_1

Očekivana apsolutna (statistička) neodređenost merenja izabranim instrumentom

Tražena maksimalna, relativna, neodređenost merenja protoka – zadato u zadatku

Period uzorkovanja nivoa – može da ostane 1s.

Na osnovu izabranog mernog instrumenta, softver metodama propagacije neodređenosti računa neodređenost merenja Q !!!

MERENJE PROTOKA – MERNO SUŽENJE

WinFlume – Izbor načina merenja nivoa

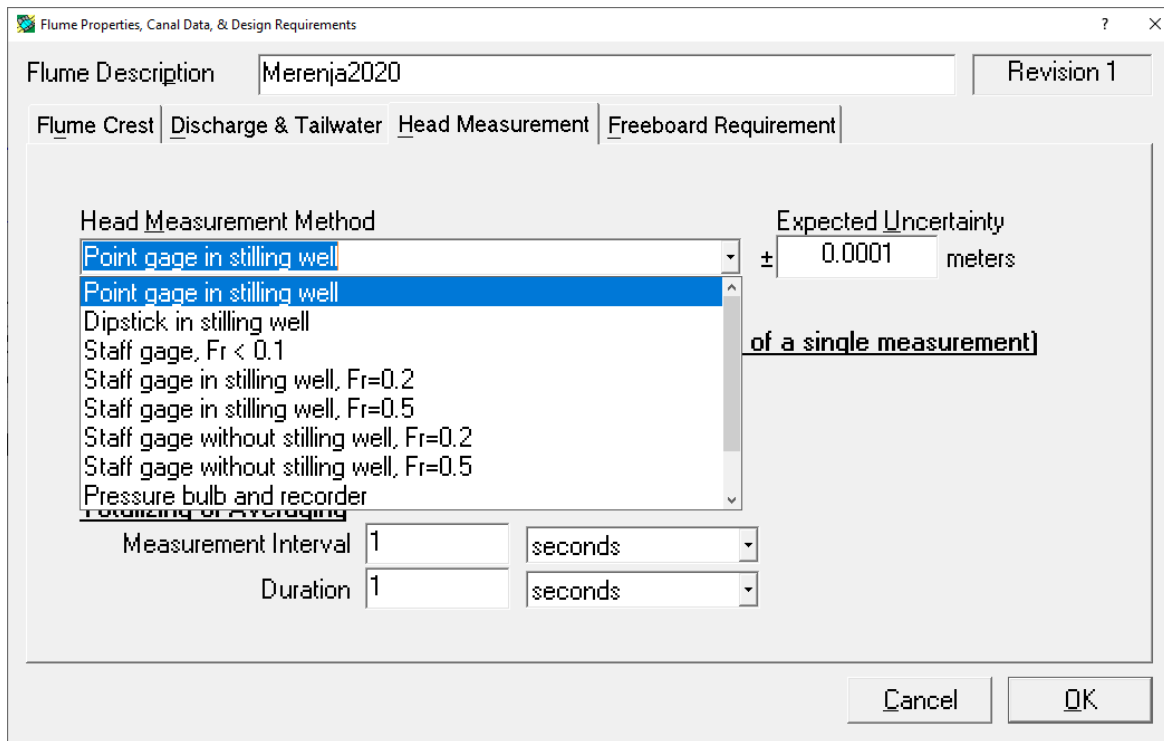

Merna igla

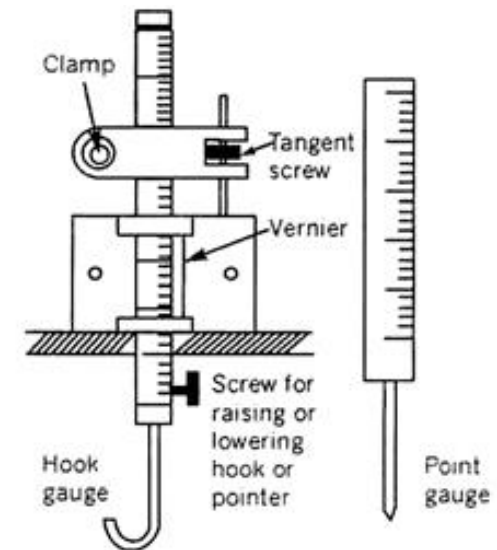
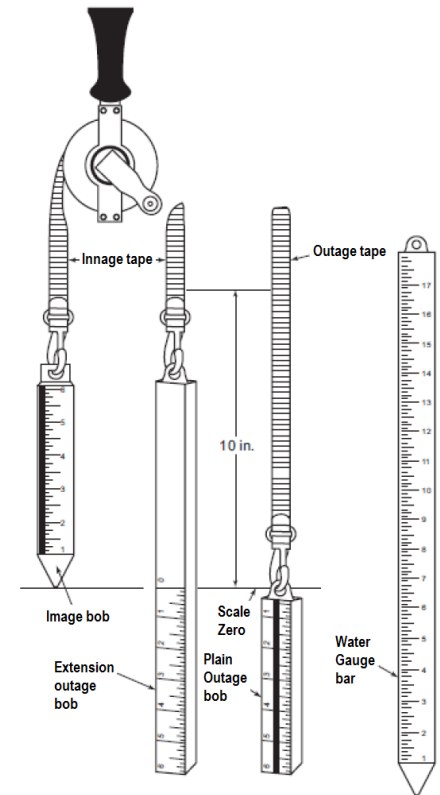
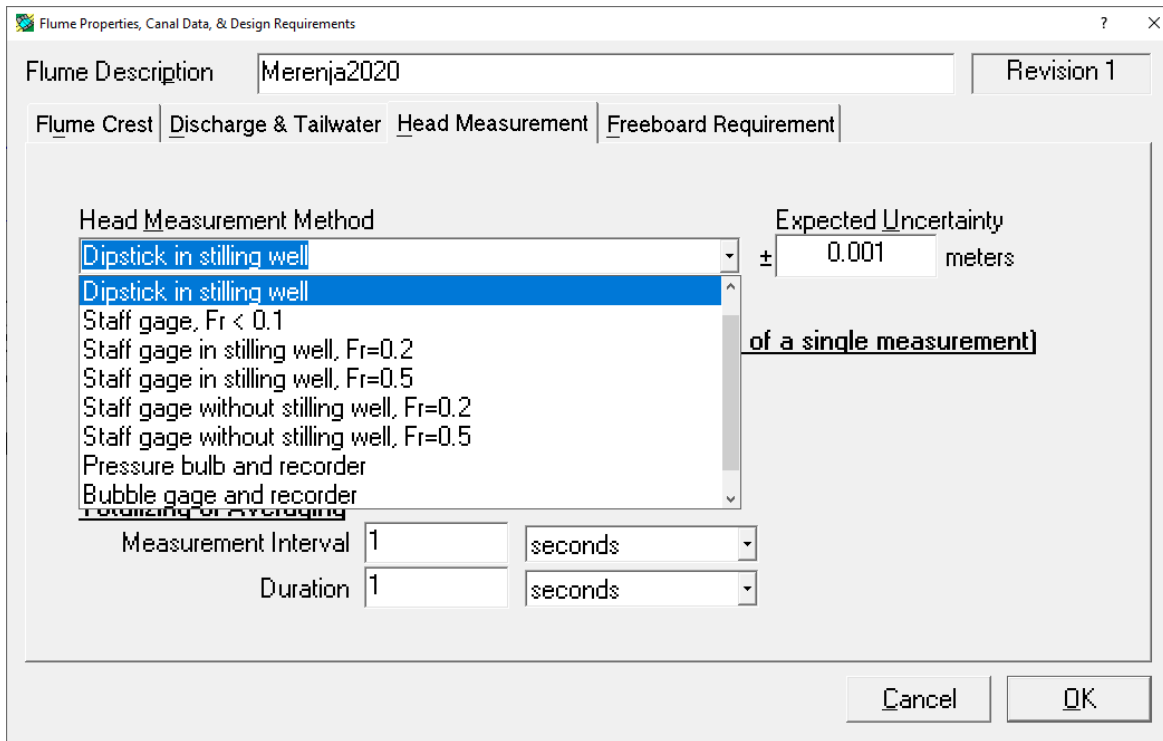

Fig. 15.5. Hook and point gauges.

MERENJE PROTOKA – MERNOSUŽENJE

WinFlume – Izbor načina merenja nivoa



MERENJE PROTOKA – MERNO SUŽENJE

WinFlume – Izbor načina merenja nivoa

Flume Properties, Canal Data, & Design Requirements

Flume Description: Merenja2020 Revision 1

Flume Crest | Discharge & Tailwater | Head Measurement | Freeboard Requirement

Head Measurement Method

Expected Uncertainty: ± 0.004 meters

of a single measurement

Staff gage, Fr < 0.1
Staff gage, Fr < 0.1
Staff gage in stilling well, Fr=0.2
Staff gage in stilling well, Fr=0.5
Staff gage without stilling well, Fr=0.2
Staff gage without stilling well, Fr=0.5
Pressure bulb and recorder
Bubble gage and recorder
Float and recorder in stilling well

Measurement Interval: 1 seconds
Duration: 1 seconds

Cancel OK

Vodomerna letva
direktno u kanalu - pri
Frudovim brojevima
manjim od 0,1

Očekivana
nedređenost je samo
ako su ispunjeni
hidraulički uslovi (Fr
broj)



MERENJE PROTOKA – MERNO SUŽENJE

WinFlume – Izbor načina merenja nivoa

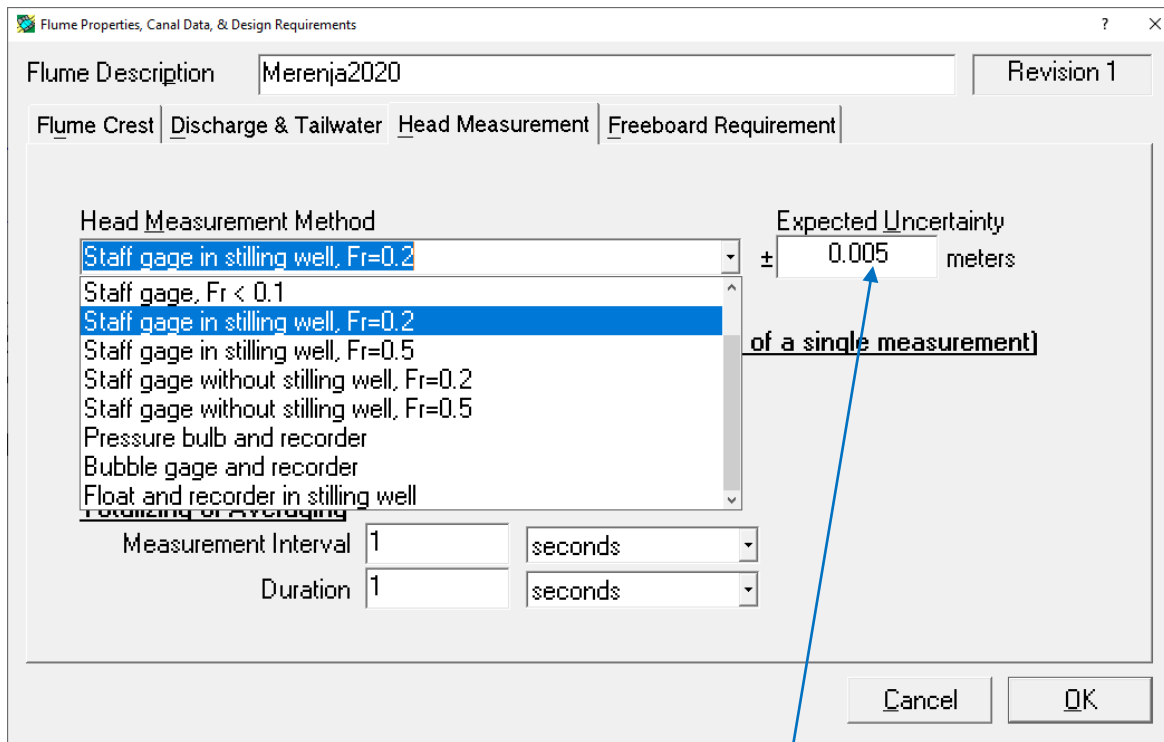

Vodomerna letva u umirujućem bunaru - pri Frudovim brojevima oko 0,2



Obratiti pažnju da se sa povećanjem brzine toka (Frudovog broja) povećava očekivana neodređenost merenja nivoa – zbog većih oscilacija nivoa

MERENJE PROTOKA – MERNO SUŽENJE

WinFlume – Izbor načina merenja nivoa

Flume Properties, Canal Data, & Design Requirements

Flume Description: Merenja2020 Revision 1

Flume Crest | Discharge & Tailwater | Head Measurement | Freeboard Requirement

Head Measurement Method: Staff gage in stilling well, Fr=0.5

Expected Uncertainty: ± 0.007 meters

of a single measurement

Measurement Interval: 1 seconds

Duration: 1 seconds

Cancel OK

Vodomerna letva u umirujućem bunaru - pri Frudovim brojevima oko 0,5



Obratiti pažnju da se sa povećanjem brzine toka (Frudovog broja) povećava očekivana neodređenost merenja nivoa – zbog većih oscilacija nivoa

MERENJE PROTOKA – MERNOSUŽENJE

WinFlume – Izbor načina merenja nivoa

Flume Properties, Canal Data, & Design Requirements

Flume Description: Merenja2020 Revision 1

Flume Crest | Discharge & Tailwater | Head Measurement | Freeboard Requirement

Head Measurement Method

Staff gage without stilling well, Fr=0.2

Staff gage, Fr < 0.1

Staff gage in stilling well, Fr=0.2

Staff gage in stilling well, Fr=0.5

Staff gage without stilling well, Fr=0.2

Staff gage without stilling well, Fr=0.5

Pressure bulb and recorder

Bubble gage and recorder

Float and recorder in stilling well

Expected Uncertainty: ± 0.007 meters

of a single measurement

Measurement Interval: 1 seconds

Duration: 1 seconds

Cancel OK

Vodomerna letva direktno u kanalu - pri Frudovim brojevima manjim od 0,2

Očekivana neodređenost je samo ako su ispunjeni hidraulički uslovi (Fr broj)



Obratiti pažnju da se sa povećanjem brzine toka (Frudovog broja) povećava očekivana neodređenost merenja nivoa – zbog većih oscilacija nivoa

MERENJE PROTOKA – MERNO SUŽENJE

WinFlume – Izbor načina merenja nivoa

Flume Properties, Canal Data, & Design Requirements

Flume Description: Merenja2020 Revision 1

Flume Crest | Discharge & Tailwater | Head Measurement | Freeboard Requirement

Head Measurement Method

Expected Uncertainty: ± 0.015 meters

of a single measurement)

Staff gage without stilling well, Fr=0.5

Staff gage, Fr < 0.1

Staff gage in stilling well, Fr=0.2

Staff gage in stilling well, Fr=0.5

Staff gage without stilling well, Fr=0.2

Staff gage without stilling well, Fr=0.5

Pressure bulb and recorder

Bubble gage and recorder

Float and recorder in stilling well

Measurement Interval: 1 seconds

Duration: 1 seconds

Cancel OK

Vodomerna letva
direktno u kanalu - pri
Frudovim brojevima
manjim od 0,5

Očekivana
nedređenost je samo
ako su ispunjeni
hidraulički uslovi (Fr
broj)



Obratiti pažnju da se sa povećanjem brzine toka (Frudovog broja) povećava očekivana neodređenost merenja nivoa – zbog većih oscilacija nivoa

MERENJE PROTOKA – MERNO SUŽENJE

WinFlume – Izbor načina merenja nivoa

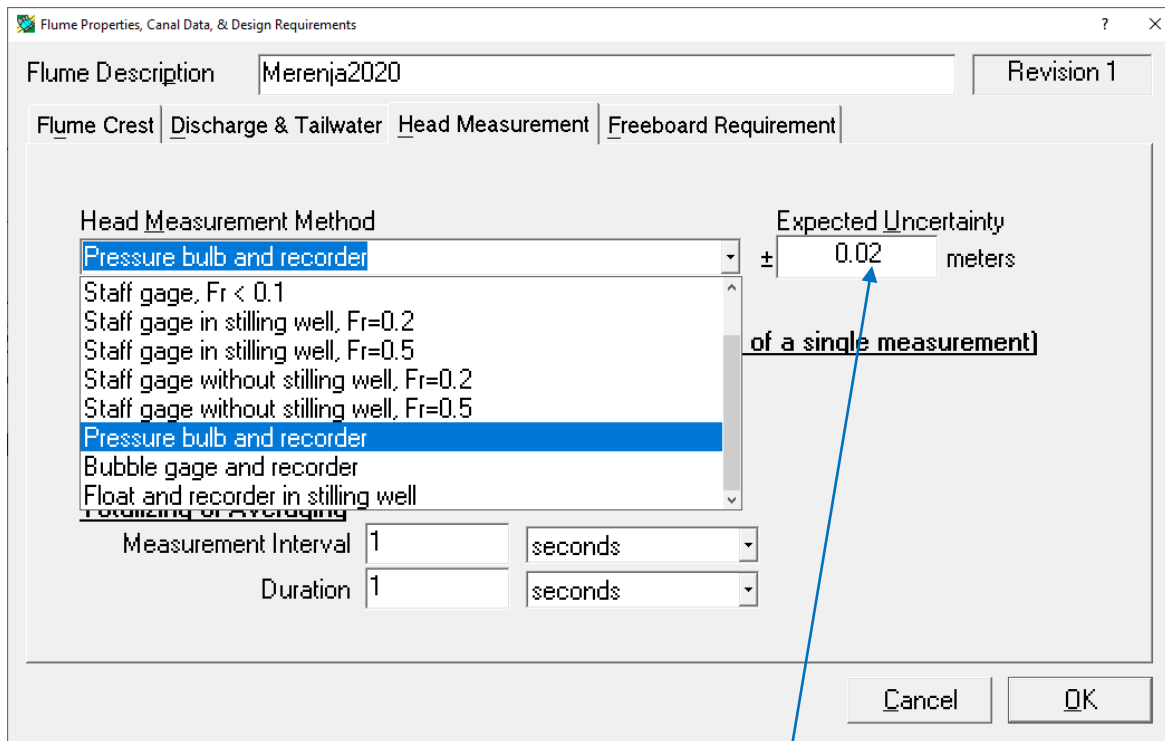

Senzor pritiska na dnu umirujućeg bunara

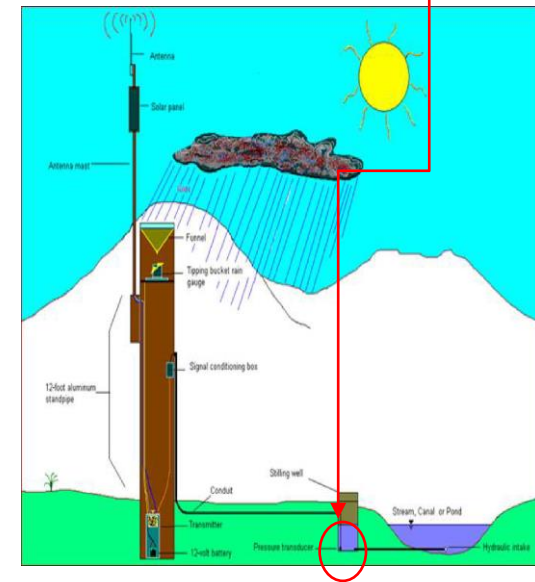

Povećava se neodređenost merenja jer se koristi uređaj sa električnim izlazom koji ima veću neodređenost, ali ima prednost u tome što može da beleži podatke i šalje u bazu

MERENJE PROTOKA – MERNO SUŽENJE

WinFlume – Izbor načina merenja nivoa

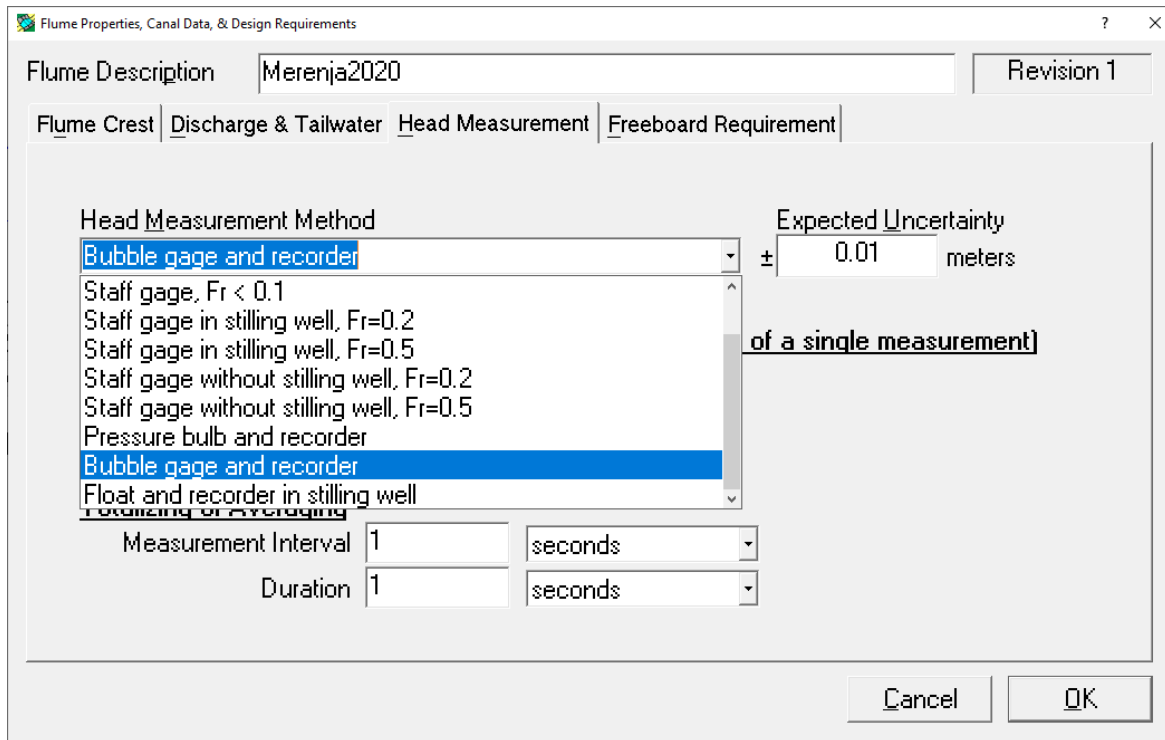

Pneumatska metoda
merenja dubine
Pogledati predavanja

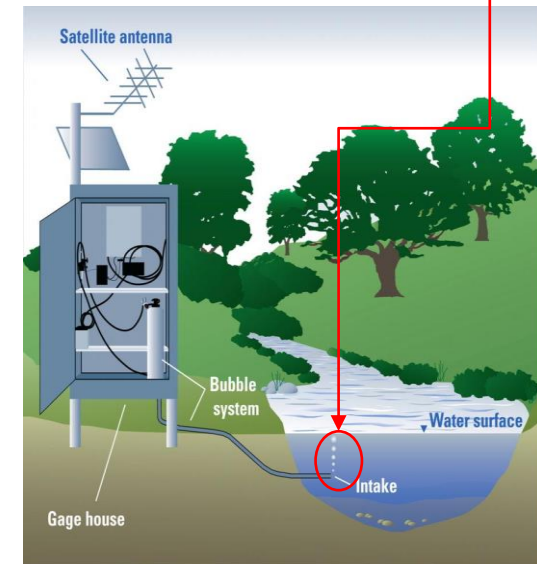

MERENJE PROTOKA – MERNO SUŽENJE

WinFlume – Izbor načina merenja nivoa

Flume Properties, Canal Data, & Design Requirements

Flume Description: Merenja2020 Revision 1

Flume Crest | Discharge & Tailwater | Head Measurement | Freeboard Requirement

Head Measurement Method: **Float and recorder in stilling well** Expected Uncertainty: ± 0.005 meters

of a single measurement

- Staff gage, Fr < 0.1
- Staff gage in stilling well, Fr=0.2
- Staff gage in stilling well, Fr=0.5
- Staff gage without stilling well, Fr=0.2
- Staff gage without stilling well, Fr=0.5
- Pressure bulb and recorder
- Bubble gage and recorder
- Float and recorder in stilling well**

Measurement Interval: 1 seconds

Duration: 1 seconds

Cancel OK

Merenje promene položaja plovka na površini vode

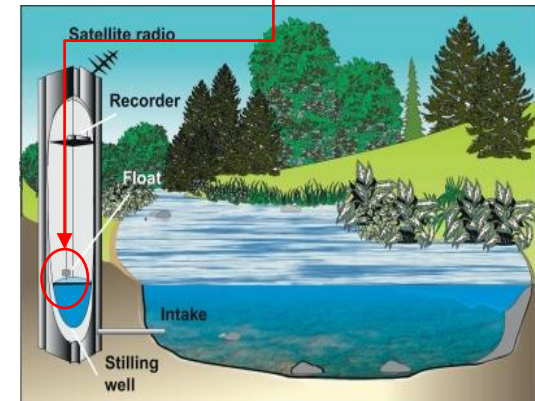

MERENJE PROTOKA – MERNO SUŽENJE

WinFlume – Zazor (Freeboard)

The screenshot shows the 'Flume Properties, Canal Data, & Design Requirements' dialog box. The 'Flume Description' is 'Merenja2020' and the 'Revision' is 'Revision 1'. The 'Freeboard Requirement' tab is selected. Under 'Absolute Distance', the 'Required Minimum Freeboard' is set to '0' meters. Under 'Percentage of Upstream Head', the 'Required Freeboard is a Percentage of the Upstream Head, h1' is selected, and the 'Required Minimum Freeboard' is set to '20 %'. A red arrow points from a text box on the right to the '20 %' value.

Uslov da visina zida bude za 20% viša od maksimalne kote kako se voda pri max protoku ne bi izlila iz kanala

MERENJE PROTOKA – MERNOSUŽENJE

WinFlume – Kriva protoka za merno mesto

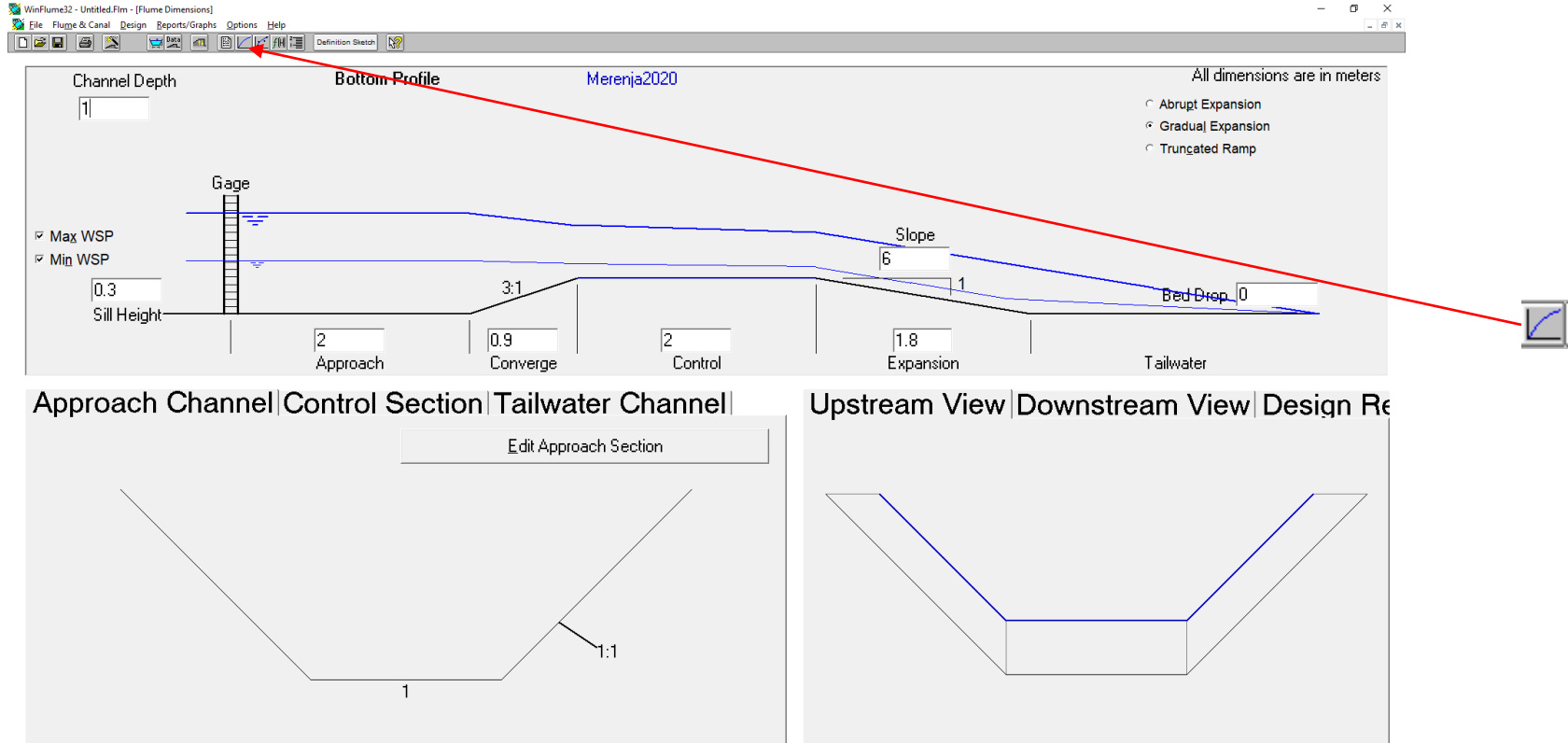

MERENJE PROTOKA – MERNO SUŽENJE

WinFlume – Kriva protoka za merno mesto

Rating Tables

Table Choices | Rating Table | H-Q Graph | Ditchrider's Table

Table Type

- Head-Discharge (H-Q)
- Discharge-Head (Q-H)

Range
Discharge in cu. m/s.

Minimum

Maximum

Increment

Smart Range

Additional Rating Table Parameters

- Froude Number (Fr)
- Required Head Loss (H1-H2)
- Head-to-Crest Length Ratio (H1/L)
- Upstream Energy Head (H1)
- Upstream Depth (y1)
- Upstream Velocity (Va)
- Discharge Coefficient (Cd)
- Velocity Coefficient (Cv)
- Maximum Allowable Tailwater Head (h2)
- Actual Tailwater Head (h2)
- Actual Tailwater Depth (y2)
- Submergence Ratio (H2/H1)
- Modular Limit

Select All

Clear All

Close

Pored Q-H zavisnosti, na krivoj protoka može da stoji još neka zavisnost

Opseg protoka za koji važi Q-H kriva – uneti svoje podatke

MERENJE PROTOKA – MERNO SUŽENJE

WinFlume – Kriva protoka za merno mesto

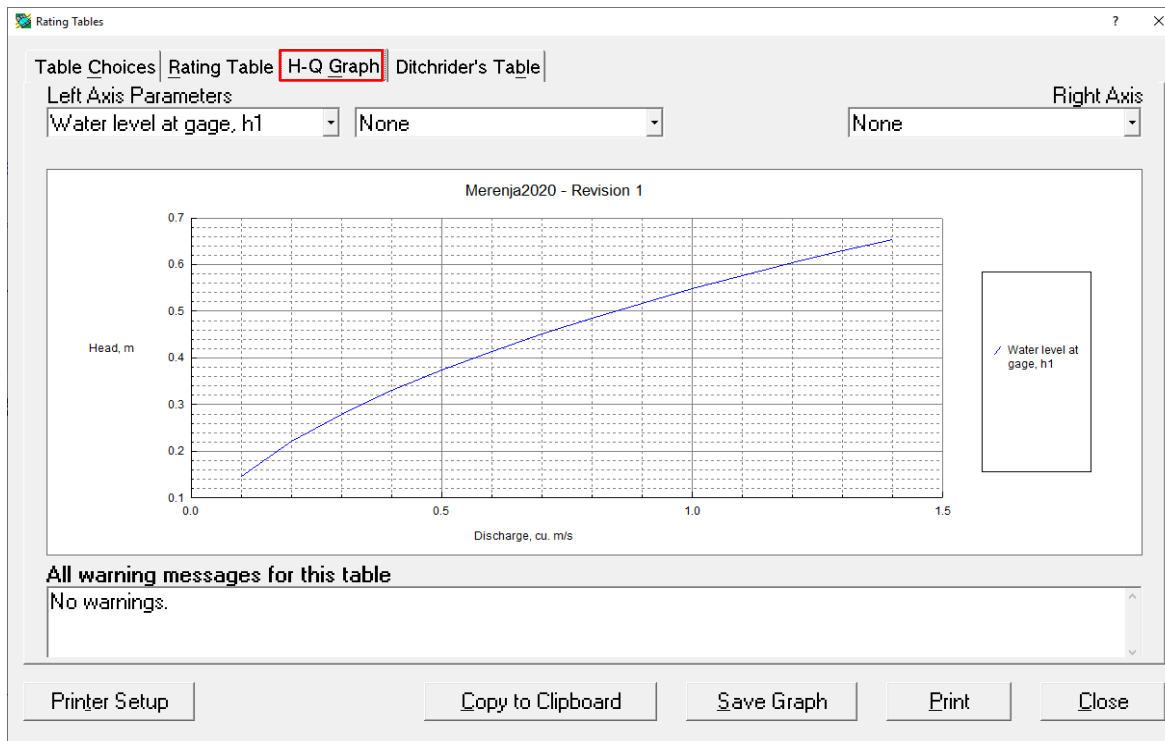

MERENJE PROTOKA – MERNO SUŽENJE

WinFlume – Zadatak

Podesiti geometriju mernog suženja i izabrati merni uređaj tako da budu ispunjeni uslovi:

- Suženje ne sme da bude šire ni u jednom delu od kanala
- Da se za ceo opseg protoka i nizvodnih dubina u suženju javi kritična dubina, tj. nepotopljeno tečenje
- Izborom mernog uređaja da neodređenost merenja protoka bude manja od 2,5% za ceo opseg protoka
- Da u kanalu na mernom mestu bude zazor od 20% od dubine
- Ako je nemoguće obezbediti nepotopljenost suženja, ukopati nizvodni deo kanala tako da se to postigne

MERENJE PROTOKA – MERNO SUŽENJE

Priložiti

- Poprečne preseke kanala i suženja
- Podužni presek kanala i suženja (situacija)
- Opis mernog uređaja
- Krivu protoka na mernom mestu
- Dokaz ispunjenosti projektnih ograničenja
- Po potrebi „crop-ovati“ slike iz WinFlume-a

MERENJE PROTOKA – MERNO SUŽENJE

Prednosti mernih suženja za merenje protoka

- Poznata veza između dubine i protoka (lakše meriti nivo)
- Zbog veće brzine u suženju ne može lako da se zapuši
- Stalno merno mesto
- Najpouzdanija praktična metoda određivanja protoka

MERENJE PROTOKA – MERNO SUŽENJE

Mane

- Stalno merno mesto
- Zauzima prostor
- Zahteva nepotopljenost suženja (ako se potopi onda moraju da se mere dve dubine umesto jedne)
- Teško je uklopiti u već postojeći sistem (najbolje kad se pravi kad i sistem)



Univerzitet u Beogradu, Građevinski fakultet



Merenje protoka u otvorenim tokovima – Projektovanje mernog suženja



Merenja u hidrotehnici

6. Vežba

Miloš Milašinović

doc. dr Damjan Ivetić

prof. dr Dušan Prodanović

doc. dr Nemanja Branislavljević

